



1030nm 2x2 Polarization Beam Combiner/Splitter

Key Features

- Low Insertion Loss
- High Extinction Ratio
- Compact In-Line Package
- High Stability and Reliability

Applications

- Polarization MUX/Demux
- High power fiber laser
- Optic sensor system
- Coherent Telecommunication Systems
- Polarization Mode Dispersion Compensator

The Polarization Beam Combiner/Splitter can be used either as a polarization beam combiner to combine light beams from two PM input fibers into a single output fiber, or as a polarization beam splitter to split light from an input fiber into two output fibers of orthogonal polarization states.

DK Photonics offers a large selection of PBS/C. These devices can handle powers rang from 300mW to 100W or other on request and have center operating wavelengths ranging from 780 nm to 2050nm.

If you do not see a standard Polarization Beam Combiner/Splitter that meets your needs, we welcome the opportunity to review your desired specification and quote a custom Polarization Beam Combiner/Splitter. Requests for custom fiber pigtailed, different wavelengths and handling power of operation or other specific needs will be readily addressed.



Package Dimension

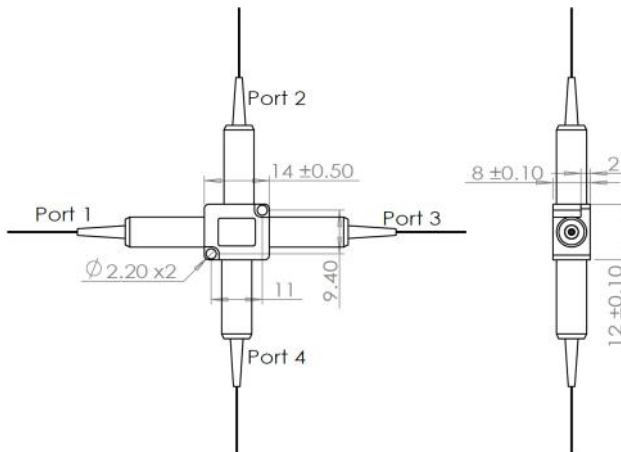

* Due to ongoing design improvements, the package size is subject to change. Please contact DK Photonics for confirmation if you have special requirements.

For more Info

Please contact us at:

Tel: +86-755-23736280

Fax: +86-755-26746512

E-mail: sales@dkphotonics.com

<https://www.dkphotonics.com>

Add.:

4F, Bldg. 18, Qinghu Industrial Park,

Dahe Road, Longhua Dis.,

Shenzhen, China 518109

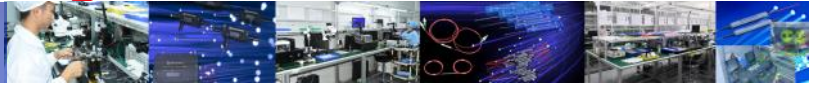

1030nm 2x2 Polarization Beam Combiner/Splitter

Performance Specifications

Parameter	Unit	Value	
Grade	-	P	
Operating wavelength	nm	1030	
Operating bandwidth	nm	±20	
Insertion loss	Typ.	dB	0.60
	Max.	dB	1.00
Min. Extinction Ratio	dB	20	
Return loss	dB	>50	
Directivity	dB	>50	
Max. Power Handling	W	0.5, 1, 2, 3, 5, 10, 20	
Tensile Load	N	< 5	
Fiber Type	Port 3&Port 4	-	PM980
	Port 1&Port2 (Same Fiber or Corresponding SM Fiber)	-	1060-XP, or PM980
Operating temperature	°C	-5 ~ +70	
Storing temperature	°C	-40 ~ +85	
Package dimension	mm	14x12x8	

1. above specifications are for device without connector. All parameters are tested at room temperature.
2. For devices with connectors, IL will be 0.3dB higher, RL will be 5dB lower and ER will be 2dB lower. The default connector key is aligned to slow axis. Power transmits through the connector less than 2W.
3. For >20W high power applications, we will use heat sink package, contact DK Photonics for details.
4. Since the light is bidirectionally reversible, PBC can also be used as PBS.

Order information P/N: PBC/PBS-2x2-①-②-③-④-⑤-⑥-⑦

When you inquire, please provide the correct P/N number according to our ordering information and attach the appropriate description would be better. If need any connector, we do not recommend choosing a 250µm bare fiber pigtail.

①	②	③	④	⑤	⑥	⑦
Grade	Operating Wavelength	Power Handling (Total)	Fiber type (Port1&2)	Pigtails Diameter	Fiber Length	Connector
P:P	30:1030nm	L:<0.5W	SM:SM fiber	25:250µm	08:0.8m	00: None
	XX: Others	1:1W	PM1:PM fiber-0°	90:900µm	10:1.0m	FP: FC/PC
		2:2W	PM2:PM fiber-45°	XX: Others	XX: Others	FA: FC/APC
		5:5W				XX: Others
		10:10W				

Part Number Example: PBS-2X2-P-30-L-PM-25-10-00

Description: 1030nm 2X2 Polarization Beam Splitter, 0.5W power, P grade, PM980 fiber for port 1 & 2, 0 degree alignment output, with bare fiber, 1.0m fiber length, and no connectors at all ports.

Ordering Information for Custom Parts

If you need to customize other specifications, please provide detailed description for your requirement.

2X2 PBS More Details Regarding Routing path:

Polarization Beam Splitter, Port 1/Port 2 SM fiber
Port 1 & Port 2: SM fiber, Input non polarized light

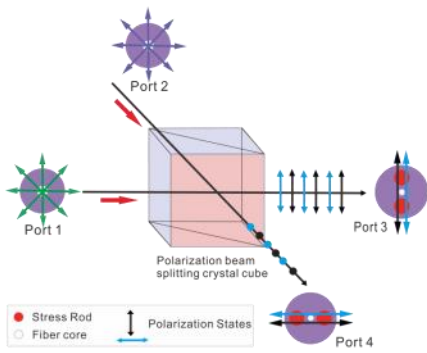

Polarization Beam Splitter, all PM fiber
Port 1: slow axis aligned 45° to Port 3
Port 2: slow axis aligned 45° to Port 4

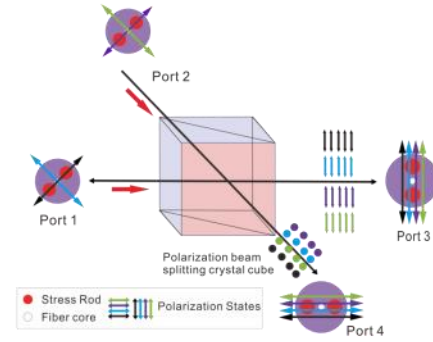

Polarization Beam Splitter, all PM fiber
Port 1: slow axis aligned 0° to Port 3
Port 2: slow axis aligned 0° to Port 4

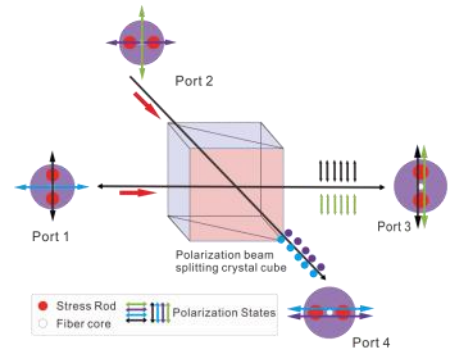

Polarization Beam Combiner, Port 1/Port 2 SM fiber
Port 1 & Port 2: SM fiber, Input non polarized light

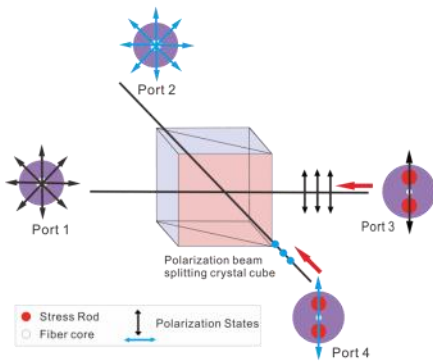

Polarization Beam Combiner, all PM fiber
Port 1: slow axis aligned 45° to Port 3
Port 2: slow axis aligned 45° to Port 4

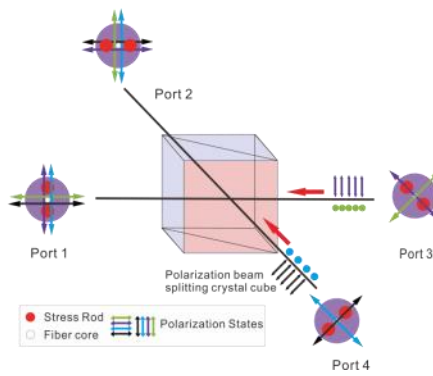

Polarization Beam Combiner, all PM fiber
Port 1: slow axis aligned 0° to Port 3
Port 2: slow axis aligned 0° to Port 4

