

1064nm High Power Polarization Beam Combiner/Splitter

Key Features

- Low Insertion Loss
- High Extinction Ratio
- Compact In-Line Package
- High Stability and Reliability

The Polarization Beam Combiner/Splitter can be used either as a polarization beam combiner to combine light beams from two PM input fibers into a single output fiber, or as a polarization beam splitter to split light from an input fiber into two output fibers of orthogonal polarization states.

DK Photonics offers a large selection of PBS/C. These devices can handle powers rang from 300mW to 10W or other on request, and have center operating wavelengths ranging from 780 nm to 2000nm.

If you do not see a standard Polarization Beam Combiner/Splitter that meets your needs, we welcome the opportunity to review your desired specification and quote a custom Polarization Beam Combiner/Splitter. Requests for custom fiber pigtails, different wavelengths and handling power of operation or other specific needs will be readily addressed.

Applications

- High power Fiber Laser
- High power Fiber Amplifier
- Optic sensor system
- Optic transmit system



Package Dimension

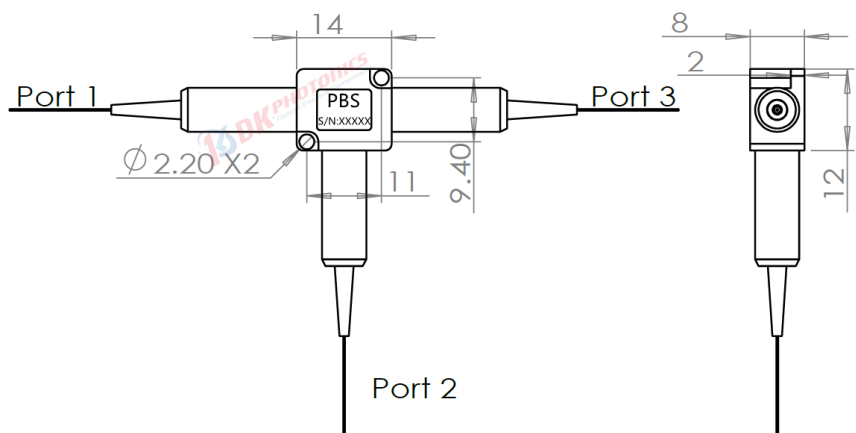

1. Optical Path: Port 1 Input, Port 2 /Port 3 output, Port 3 Panda fiber is aligned to P1.
2. Due to ongoing design improvements, the package size is subject to change. Please contact DK Photonics for confirmation.

For more Info

Please contact us at:

Tel: +86-755-23736280

Fax: +86-755-26746512

E-mail: sales@dkphotonics.com

<https://www.dkphotonics.com>

Add.:

4F, Bldg. 18, Qinghu Industrial Park,
Dahe Road, Longhua Dis.,
Shenzhen, China 518109



1064nm High Power Polarization Beam Combiner/Splitter

Performance Specifications

Parameter	Unit	Value
Operating wavelength	nm	1030
Operating bandwidth	nm	±20
Typical insertion loss	dB	0.35
Max. insertion loss	dB	0.60
Min. Extinction Ratio	dB	20
Return loss	dB	>50
Directivity	dB	>50
Max. Power Handling	W	5, 10, 20,30
Tensile Load	N	< 5
Fiber Type	Port 1	- 1060-XP, or LMA DC fiber
	Port2 & Port 3	- PM980-XP, or PM LMA DC fiber
Operating temperature	°C	-5 ~ +70
Storing temperature	°C	-40 ~ +85
Package dimension	mm	14x12x8

1. above specifications are for device without connector. All parameters are tested at room temperature.
2. For devices with connectors, IL will be 0.3dB higher, RL will be 5dB lower and ER will be 2dB lower. The default connector key is aligned to slow axis. Power transmits through the connector less than 2W.
3. For >50W high power applications, we will use heat sink package, contact DK Photonics for details.
4. Since the light is bidirectionally reversible, PBC can also be used as PBS.

Order information P/N: HPPBC/PBS-①-②-③-④-⑤-⑥

When you inquire, please provide the correct P/N number according to our ordering information, and attach the appropriate description would be better. If need any connector, we do not recommend choosing a 250µm bare fiber pigtail.

①	②	③	④	⑤	⑥
Operating Wavelength	Power Handling(Total)	Fiber type (Port 1)	Pigtails Diameter	Fiber Length	Connector
30:1030nm	5:5W	1:SM fiber	25:250µm	08:0.8m	00: None
64:1064nm	10:10W	3:PM fiber, slow axis	90:900µm	10:1.0m	FP: FC/PC
XX: Others	20:20W	aligned to port 3	XX: Others	XX: Others	FA: FC/APC
	30:30W	XXX: fiber name			XX: Others

Part Number Example: HPPBC-64-20-3P10/125/08D-25-10-00

Description: 1064nm High Power Polarization Beam Combiner, 20W power, PLMA-GDF-10/125-M fiber at all ports, with bare fiber, 1.0m fiber length, and no connectors at all ports.

Ordering Information for Custom Parts

If you need to customize other specifications, please provide detailed description for your requirement.